



DAL SIN LINE®



Aluminum Flex Venting

"Dalsin Line"® aluminum flexible liners are used for venting category 1 and direct vent appliances. Manufactured using Type 3003 aluminum, this heavy 2-ply liner is made from .005" thick, high grade aluminum for a total thickness of .010".

Key Features

- 1 Type 3003 (.030") thickness Aluminum components
- 2 2-ply, Type 3003 (.010") thickness
- 3 Durable Interlock flexible liner for superior strength

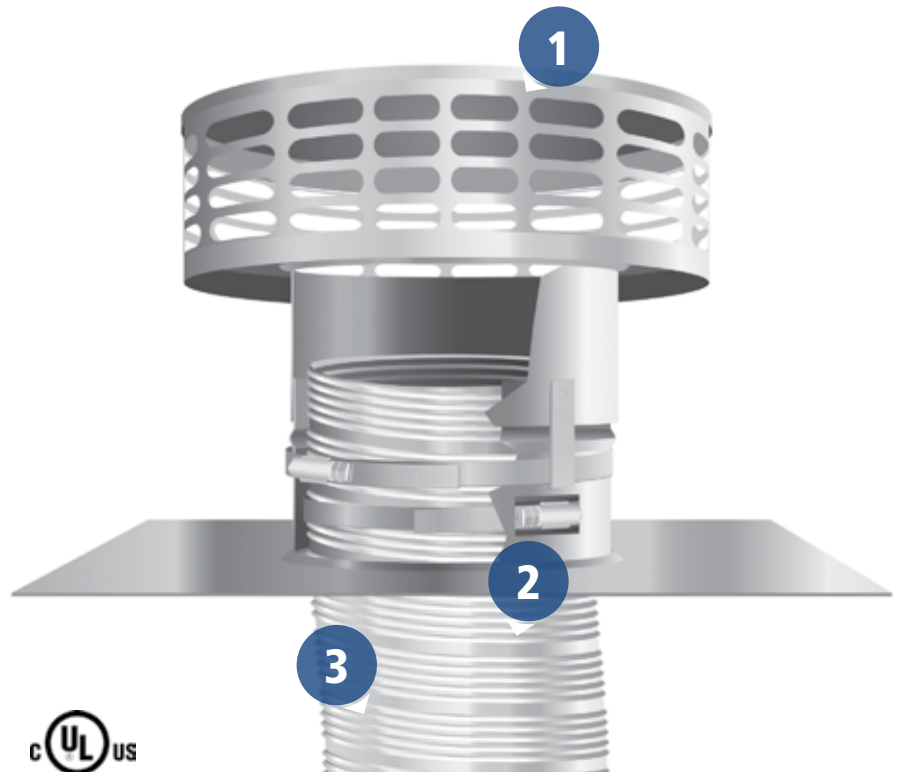

Applications

Gas Appliance Venting Into Masonry Chimney

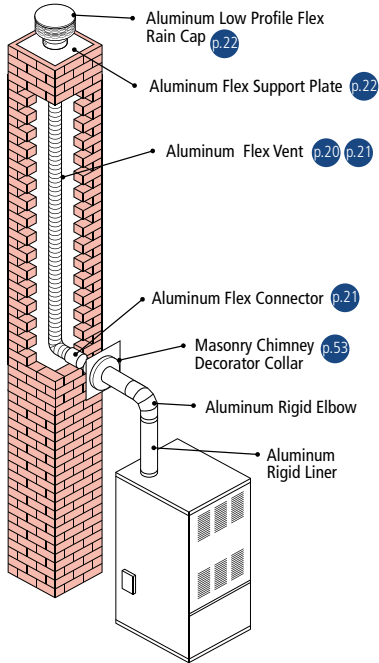

B-Vent Gas Insert

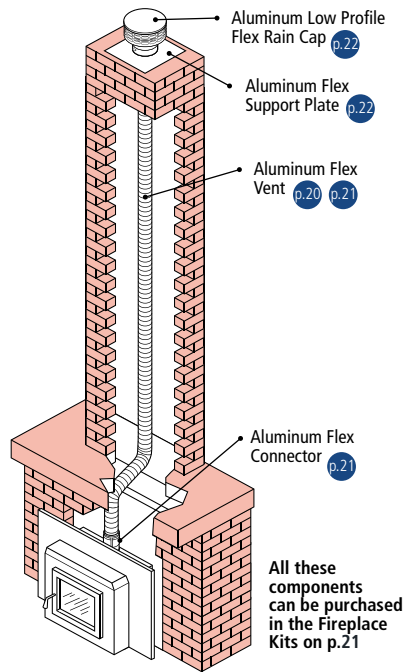

Direct Vent Gas Insert

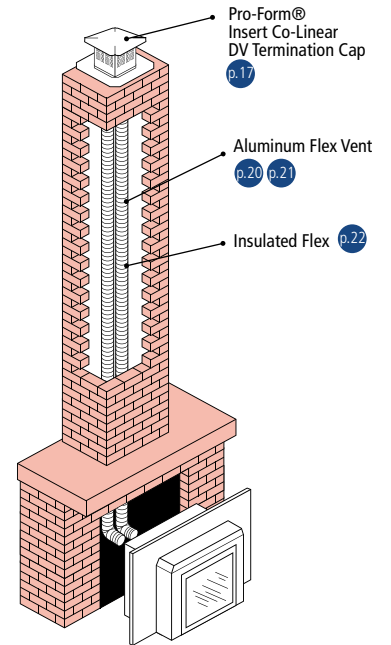

Back-to-back Application with Double Cap

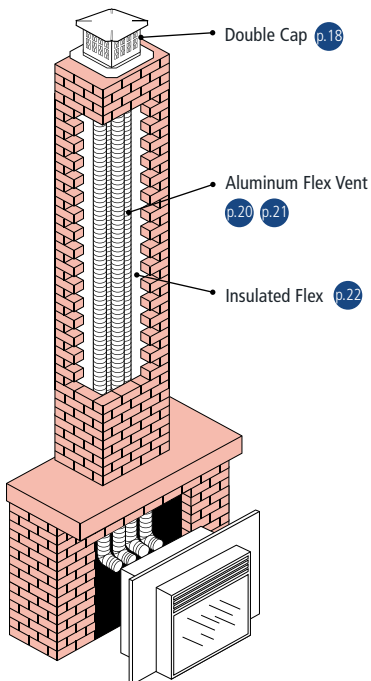

Aluminum Flex Venting

DALSIN LINE®

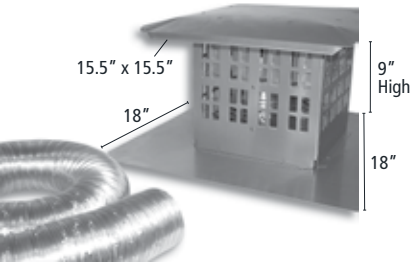

Pro-Form® Insert Co-Linear DV Termination Kit			
		Aluminum	Black Powder Coat
Diameter	Flex Included	Order #	Order #
3" x 3"	30' and 4'	942033430	942033430B
3" x 3"	2 ea. 30'	94203360	94203360B
3" x 3"	35' and 4'	942033435	942033435B
3" x 3"	2 ea. 35'	94203370	94203370B
3" x 4"	30' and 4'	942034430	942034430B
3" x 4"	2 ea. 30'	94203460	94203460B
3" x 4"	35' and 4'	942034435	942034435B
3" x 4"	2 ea. 35'	94203470	94203470B
4" x 4"	30' and 4'	942044430	942044430B
4" x 4"	2 ea. 30'	94204460	94204460B
4" x 4"	35' and 4'	942044435	942044435B
4" x 4"	2 ea. 35'	94204470	94204470B

Kit includes: cap, (2) 30' or 35' lengths of flex or (1) 30' or (1) 35' and (1) 4' flex



Pro-Form® Insert Co-Linear DV Termination Kit w/High Wind Cap/Square Base			
		Aluminum	Black Powder Coat
Diameter	Flex Included	Order #	Order #
3" x 3"	30' and 4'	942033430HWS	942033430HWSB
3" x 3"	2 ea. 30'	94203360HWS	94203360HWSB
3" x 3"	35' and 4'	942033435HWS	942033435HWSB
3" x 3"	2 ea. 35'	94203370HWS	94203370HWSB
3" x 4"	30' and 4'	942034430HWS	942034430HWSB
3" x 4"	2 ea. 30'	94203460HWS	94203460HWSB
3" x 4"	35' and 4'	942034435HWS	942034435HWSB
3" x 4"	2 ea. 35'	94203470HWS	94203470HWSB

Kit includes: cap, (2) 30' or 35' lengths of flex or (1) 30' or (1) 35' and (1) 4' flex

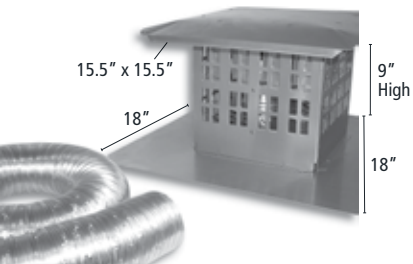

Pro-Form® Insulated Aluminum Flex Kits			
		Aluminum	Black Powder Coat
Diameter	Flex Included	Order #	Order #
3" x 3"	30' x 2	942103360	942103360B
3" x 3"	35' x 2	942103370	942103370B
3" x 4"	30' x 2 (4" Flex Insulated)	942103460	942103460B
3" x 4"	35' x 2	942103470	942103470B
4" x 4"	30' x 2	942104460	942104460B
4" x 4"	35' x 2	942104470	942104470B

Kit includes: cap, (2) 30' or 35' lengths of flex exhaust liner insulated

Aluminum Flex Venting

DALSIN LINE®

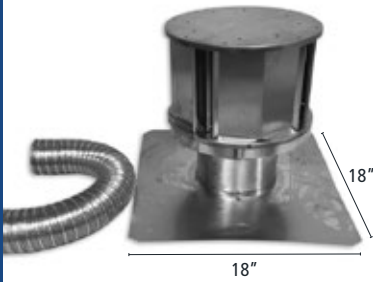

Pro-Form® Insulated Aluminum Flex Kits w/High Wind Cap/Square Base

C B 1 12

		Aluminum	Black Powder Coat
Diameter	Flex Included	Order #	Order #
3" x 3"	30' x 2	942103360HWS	942103360HWSB
3" x 3"	35' x 2	942103370HWS	942103370HWSB
3" x 4"	30' x 2 (4" Flex Insulated)	942103460HWS	942103460HWSB
3" x 4"	35' x 2	942103470HWS	942103470HWSB

Kit includes: cap, (2) 30' or 35' lengths of flex exhaust liner insulated.

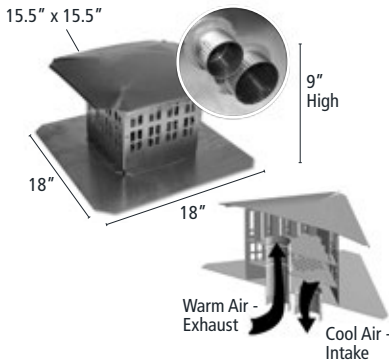

Pro-Form® Insert Co-Linear DV Termination Cap

C B 1 6

		Aluminum	Black Powder Coat
Diameter	Order #	Order #	Order #
3" x 3"	940033	940033B	
3" x 4"	940034	940034B	
4" x 4"	940044	940044B	



Pro-Form® SS Vertical Round Co-Linear Cap

C B 1 6

Diameter	Order #
3" x 3" and 3" x 4"	940034RDSS

Includes 3" x 4" adaptor

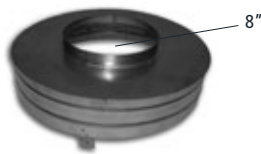

Pro-Form® Base for SS Vertical Round Co-Linear Cap

C B 1 6

Base	Order #
12.5"	94830234RDSS
14.5"	94830434RDSS
17.5"	94830734RDSS

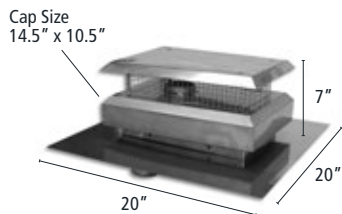

Pro-Form® SS Vertical Co-Linear Rectangle Caps

C B 1 6

Diameter	Order #
3" x 3" and 3" x 4"	940034EC26SS

Note: Each cap comes with 3" x 4" adaptor.

Aluminum Flex Venting

DALSIN LINE®

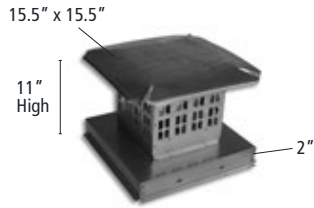

Pro-Form® VCL Termination Cap with Stainless Steel Base			
	8" x 8" SS Base	8" x 13" SS Base	13" x 13" SS Base
Diameter	Order #	Order #	Order #
3" x 3"	9400330808SS	9400330813SS	9400331313SS
3" x 4"	9400340808SS	9400340813SS	9400341313SS
4" x 4"	9400440808SS	9400440813SS	9400441313SS

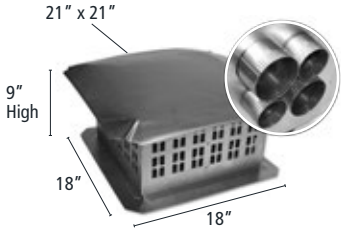

Pro-Form® Insert Co-Linear DV Double Termination Cap	
Diameter	Order #
3" x 3"	940033DBL
3" x 4"	940034DBL
4" x 4"	940044DBL

Note: Used for back-to-back inserts.

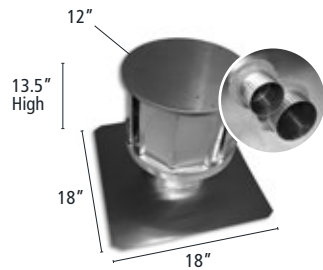

Pro-Form® Round Co-Linear DV Termination Cap (with Square Base)	
Diameter	Order #
3" x 3"	940033HWS
3" x 4"	940034HWS

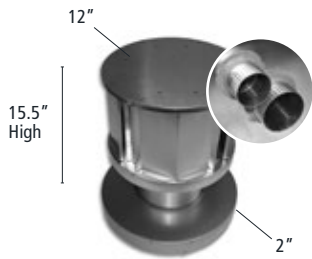

Pro-Form® Vertical Round Co-Linear DV Termination Cap (with Round Base)		
Diameter	Base	Order #
3" x 3"	12.5	9400332RD
3" x 3"	14.5	9400334RD
3" x 3"	17.5	9400337RD
3" x 4"	12.5	9400342RD
3" x 4"	14.5	9400344RD
3" x 4"	17.5	9400347RD



Pro-Form® Vertical Round Co-Linear DV Termination Cap (with No Base)	
Diameter	Order #
3" x 3"	940033HWN
3" x 4"	940034HWN

Note: Separate base on page 19.

Aluminum Flex Venting

DALSIN LINE®

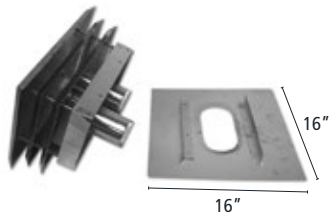

Pro-Form® Vertical Co-Linear Regency DV Termination Cap



Diameter	Order #
3" x3" and 3" x4"	940034RC

Each Cap Includes 4" x3" Reducer.

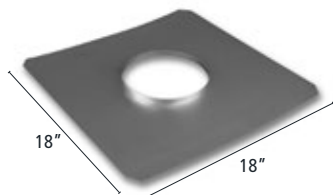

Pro-Form® Vertical Square Base Only for Co-Linear Cap



Diameter	Base	Order #
3" x3"	18" x18"	940033HWPLT
3" x4"	18" x18"	940034HWPLT



Pro-Form® Vertical Round Base Only for Co-Linear Cap



Diameter	Base	Order #
3" x3"	12.5	94830233RD
3" x3"	14.5	94830433RD
3" x3"	17.5	94830733RD
3" x4"	12.5	94830234RD
3" x4"	14.5	94830434RD
3" x4"	17.5	94830734RD



Bat Resistant Screen Kit



Diameter	Order #
Square Cap	949812
Round Cap	949824

Note: For use on any Pro-Form cap to keep bats out!

Aluminum Flex Venting

DALSIN LINE®



Aluminum Flex Only – 25 Foot			C	B	1	16
	Without Ends		With Ends			
Size	Order #	Order #				
2"	95270225	–				
3"	95270325	95070325				
4"	95270425	95070425				
5"	95270525	95070525				
6"	95270625	95070625				
7"	95270725	95070725				
8"	95270825	95070825				

Pallet quantities may vary. Call for exact amounts.



Aluminum Flex Only – 35 Foot			C	B	1	16
	Without Ends		With Ends			
Size	Order #	Order #				
3"	95270335	95070335				
4"	95270435	95070435				
5"	95270535	95070535				
6"	95270635	95070635				
7"	95270735	95070735				
8"	95270835	95070835				

Note: Larger diameters and custom lengths available; Call for pricing

Pallet quantities may vary. Call for exact amounts.

Aluminum Flex Only – 50 Foot		C	B	1	12
	Without Ends				
Size	Order #				
3"	95270350				
4"	95270450				
6"	95270650				

Pallet quantities may vary. Call for exact amounts.

Aluminum Flex – 10 Foot Extension			C	B	1	6
	Without Ends		With Ends			
Size	Order #	Order #				
3"	95270310	95070310				
4"	95270410	95070410				
5"	95270510	95070510				
6"	95270610	95070610				
7"	95270710	95070710				
8"	95270810	95070810				

Box quantities may vary. Call for exact amounts.

Aluminum Flex Venting

DALSIN LINE®

2 Piece Flex Only – 50 Foot (2x25 Foot Sections) C B 1 16

	Without Ends	With Ends
Size	Order #	Order #
3"	95280350	95080350
3"/4"	952803450	–
4"	95280450	95080450

Note: For use with fireplaces with air intakes
☰ Pallet quantities may vary. Call for exact amounts.

2 Piece Flex Only – 60 Foot (2x30 Foot Sections) C B 1 12

	Without Ends	With Ends
Size	Order #	Order #
3"	95280360	95080360
3"/4"	952803460	–
4"	95280460	95080460

☰ Pallet quantities may vary. Call for exact amounts.

2 Piece Flex Only – 70 Foot (2x35 Foot Sections) C B 1 12

	Without Ends	With Ends
Size	Order #	Order #
3"	95280370	95080370
3"/4"	952803470	–
4"	95280470	95080470

☰ Pallet quantities may vary. Call for exact amounts.



Fireplace Kit – 25 Foot C B 1 16

	Without Ends	With Ends
Size	Order #	Order #
3"	95250325	95050325
4"	95250425	95050425

☰ Pallet quantities may vary. Call for exact amounts.

Fireplace Kit – 35 Foot C B 1 12

	Without Ends	With Ends
Size	Order #	Order #
3"	95250335	95050335
4"	95250435	95050435

Fireplace Kit includes: Low Profile Rain Cap, 16x16 Top Plate, 2 Ply Flexible Aluminum Liner
☰ Pallet quantities may vary.



Aluminum Flex Connector C B 4 6

Size	Order #
3"	95090390
4"	95090490
5"	95090590
6"	95090690
7"	95090790
8"	95090890

Aluminum Flex Venting

DALSIN LINE®



Aluminum Tapered Reducer		C	B	4	6
Size	Order #				
4" x 3"	91130403				



Aluminum Flex Pull Cone		C	B	1	6
Size	Order #				
3"	95091				
4"	95094				



Aluminum Low Profile Flex Rain Cap		C	B	4	6
Size	Order #				
3"	91360300				
4"	91360400				
5"	91360500				
6"	91360600				
7"	91360700				
8"	91360800				

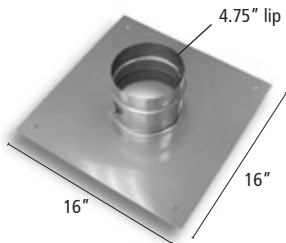

Aluminum Flex Support Plate – 16" x 16" with Hose Clamp		C	B	4	6
Size	Order #				
3"	95200316				
4"	95200416				
5"	95200516				
6"	95200616				
7"	95200716				
8"	95200816				



Aluminum Insulated Flex		C	B	1	6
Size	Order #				
3" x 30 foot	9550030430				
3" x 35 foot	9550030435				
4" x 30 foot	9550040530				
4" x 35 foot	9550040535				
5" x 30 foot	9550050630				
5" x 35 foot	9550050635				
6" x 30 foot	9550060730				
6" x 35 foot	9550060735				
8" x 30 foot	9550080930				
8" x 35 foot	9550080935				

B-Vent Masonry Chim not rated for thru a combustible wall.

Aluminum Insulated Flex Connector – Call for part numbers and pricing.

Note: Great for gas inserts!; Insulation = .25" Thick