



Pro-Form[®]
Direct Vent System



Pro-Form[®] Direct Vent System

The Pro-Form direct vent system has best in industry features that provide ease of installation, extreme durability and superior performance. The Pro-Form direct vent system is fully tested and listed to ANSI Z21.88-2009 / CSA 2.33 (2009)

Key Features

- 1 Die formed stainless steel spacer bracket** for strength and perfect alignment inner pipe.
Stainless steel bracket welded to inner stainless steel pipe and riveted to outer galvanized pipe. Welds between stainless steel and galvanized can be weak.
- 2 Hydraulically formed pipe ends** create a perfect fit for a safe & leak free vent system.
- 3 Type 430 – 28 gauge stainless steel** exhaust vent – corrosion resistant material for added safety and durability.
- 4 Hard tooled twist lock** connection system for easy secure installation of vent system.
- 5 Continuous laser (butt) weld** on inner and outer pipe for a safe leak-free vent system.
- 6 Durable G90 26 gauge galvanized material**
Black pipe is powder coated instead of (liquid paint) for a beautiful and extremely durable finish.
- 7 Listed with 95% of the fireplace manufactures.**
Call or email for current listings.

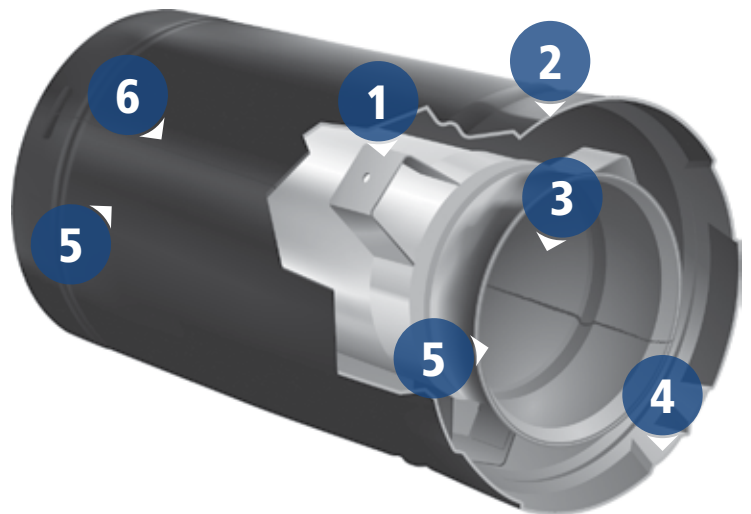

Patented USA #9,377,196
Patented USA #8,734,209
Patented USA #D562,959

Applications

Cathedral Ceiling Stove

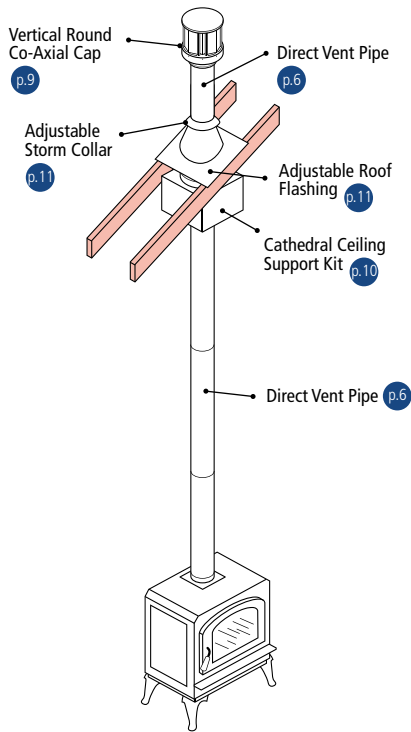

Co-Linear Insert

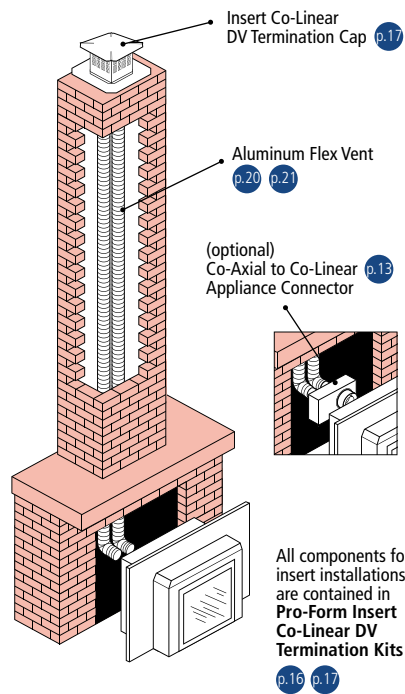

Fireplace Vertical Termination

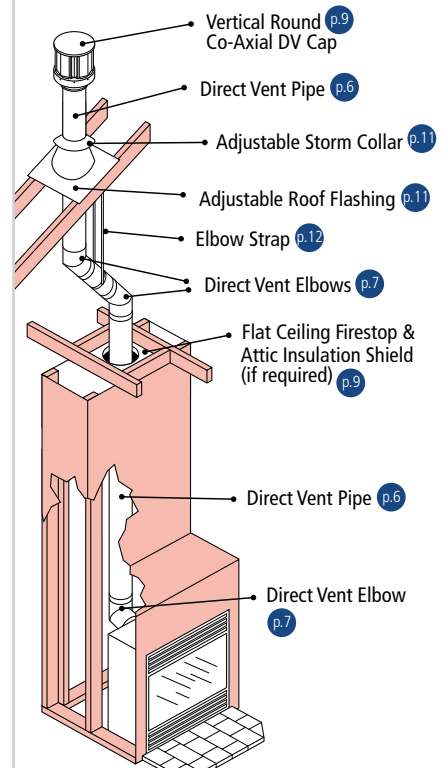

Masonry Chimney Stove Installation

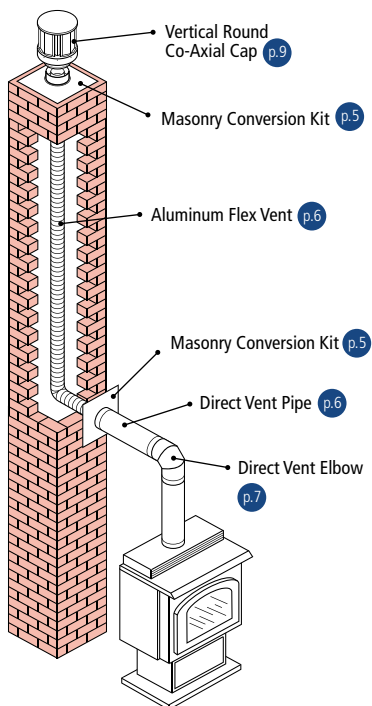

Metal Chimney Conversion

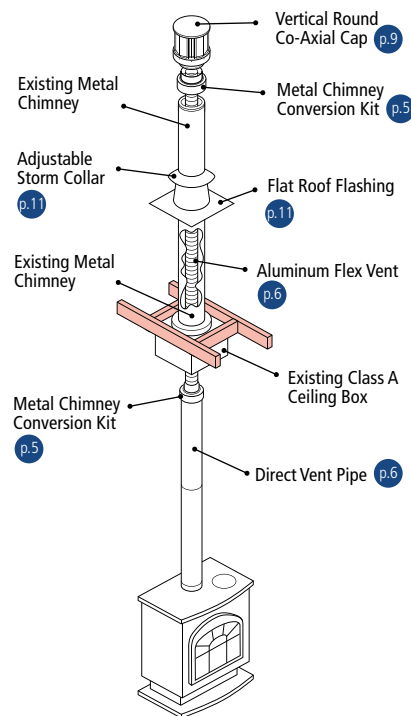

Stove Horizontal Termination

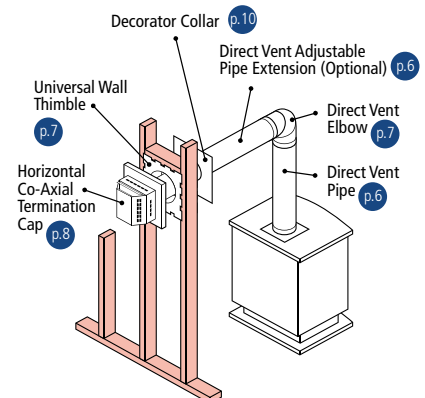

Pro-Form® Direct Vent System

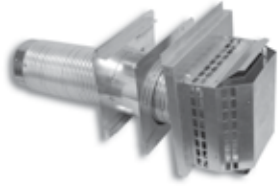

Pro-Form® Horizontal Co-Axial DV Termination Kit



	3' Flex	5' Flex	10' Flex
Diameter	Order #	Order #	Order #
4" inside 6 5/8"	DVF6-03KT	DVF6-05KT	DVF6-10KT
4" inside 7"	DVF7-03KT	DVF7-05KT	DVF7-10KT
5" inside 8"	DVF8-03KT	DVF8-05KT	DVF8-10KT

Kit includes: cap, firestop and 3', 5' or 10' of flex.

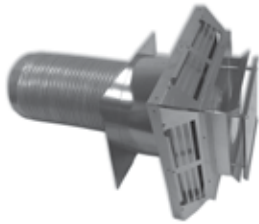

Pro-Form® Horizontal Co-Axial DV Termination Kit – With Pyramid Cap



	3' Flex	5' Flex	10' Flex
Diameter	Order #	Order #	Order #
4" inside 6 5/8"	DVF6-03KTP	DVF6-05KTP	DVF6-10KTP
4" inside 7"	DVF7-03KTP	DVF7-05KTP	DVF7-10KTP
5" inside 8"	DVF8-03KTP	DVF8-05KTP	DVF8-10KTP

Kit includes: cap, firestop and 3', 5' or 10' of flex.



Pro-Form® Metal Class A Chimney Conversion Kit (Aluminum)



Diameter	Order #	O.D.
4" inside 6 5/8" to 6" Class A	DVR6-CCK6	12"
4" inside 6 5/8" to 8" Class A	DVR6-CCK8	14.5"

Kit includes: cap, firestop and 3', 5' or 10' of flex.

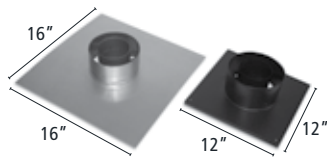

Pro-Form® Masonry Chimney Conversion Kit (Aluminum)



Diameter	Order #	O.D.
4" inside 6 5/8"	DVR6-MCK	10"
5" inside 8"	DVR8-MCK	12"

Kit includes: co-axial chimney flashing and co-axial masonry chimney adaptor and hose clamps.

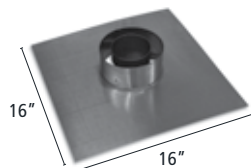

Pro-Form® Co-Axial Chimney Flashing (Aluminum)



Diameter	Order #
4" inside 6 5/8"	DVR6-CACF
5" inside 8"	DVR8-CACF



Pro-Form® Direct Vent Pipe			
		Galvanized Outer Pipe	Black Powder Coat Outer Pipe
Diameter	Length	Order #	Order #
4" Inside 6 5/8"	6"	DVR6-06	DVR6-06B
	9"	DVR6-09	DVR6-09B
	12"	DVR6-12	DVR6-12B
	18"	DVR6-18	DVR6-18B
	24"	DVR6-24	DVR6-24B
	36"	DVR6-36	DVR6-36B
	48"	DVR6-48	DVR6-48B
5" Inside 8"	6"	DVR8-06	DVR8-06B
	9"	DVR8-09	DVR8-09B
	12"	DVR8-12	DVR8-12B
	18"	DVR8-18	DVR8-18B
	24"	DVR8-24	DVR8-24B
	36"	DVR8-36	DVR8-36B
	48"	DVR8-48	DVR8-48B



Pro-Form® Direct Vent Adjustable Pipe Extension			
		Galvanized Outer Pipe	Black Powder Coat Outer Pipe
Diameter	Length	Order #	Order #
4" Inside 6 5/8"	4" to 8.5"	DVR6-08A	DVR6-08AB
	4" to 16"	DVR6-16A	DVR6-16AB
5" Inside 8"	4" to 8.5"	DVR8-08A	DVR8-08AB
	4" to 16"	DVR8-16A	DVR8-16AB



4" x 6 5/8" Co-Axial Flex Extensions	
Diameter	Order #
4" Inside 6 5/8" x 3'	DVF6-03
4" Inside 6 5/8" x 5'	DVF6-05
4" Inside 6 5/8" x 10'	DVF6-10
4" Inside 6 5/8" x 25"	DVF6-25

4" x 7" Co-Axial Flex Extensions	
Diameter	Order #
4" Inside 7" x 3'	DVF7-03
4" Inside 7" x 5'	DVF7-05
4" Inside 7" x 10'	DVF7-10
4" Inside 7" x 25"	DVF7-25

5" x 8" Co-Axial Flex Extensions	
Diameter	Order #
5" Inside 8" x 3'	DVF8-03
5" Inside 8" x 5'	DVF8-05
5" Inside 8" x 10'	DVF8-10
5" Inside 8" x 25"	DVF8-25

Pro-Form® Direct Vent System



Pro-Form® Direct Vent Elbow



		Galvanized Outer Pipe	Black Powder Coat Outer Pipe
Diameter	Angle	Order #	Order #
4" Inside 6 5/8"	30 Degree	DVR6-E30	DVR6-E30B
	45 Degree	DVR6-E45	DVR6-E45B
	60 Degree	DVR6-E60	DVR6-E60B
	90 Degree	DVR6-E90	DVR6-E90B
5" Inside 8"	30 Degree	DVR8-E30	DVR8-E30B
	45 Degree	DVR8-E45	DVR8-E45B
	60 Degree	DVR8-E60	DVR8-E60B
	90 Degree	DVR8-E90	DVR8-E90B

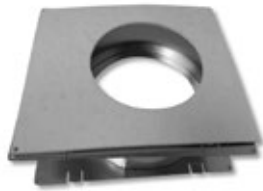

Pro-Form® Telescoping Wall Thimble Insulation Only



Diameter	Order #
4" inside 6 5/8"	DVR6-WTINS
5" inside 8"	DVR8-WTINS

Note: For insulating Wall Thimble for an air tight seal. Self adhesive backing. Sold in packages of 6.

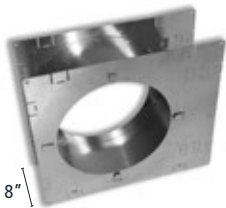

4" to 8"

Pro-Form® Universal Wall Thimble



Diameter	Framing Dimension			Order #
	1" clearance	2" clearance	3" clearance	
4" Inside 6 5/8"	9.5" x 9.5"	9.5" x 10.5"	9.5" x 11.5"	DVR6-WTU
5" Inside 8"	11" x 11"	11" x 12"	11" x 13"	DVR8-WTU

Note: Telescopes 4" to 8"

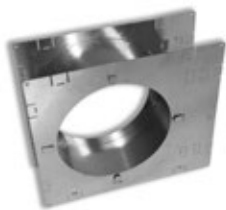

Pro-Form® Fire Stop (For Flex)



Diameter	Framing Dimension			Order #
	1" clearance	2" clearance	3" clearance	
4" Inside 6 5/8"	9.5" x 9.5"	9.5" x 10.5"	9.5" x 11.5"	DVF6-WT
4" Inside 7"	9.5" x 9.5"	9.5" x 10.5"	9.5" x 11.5"	DVF7-WT
5" Inside 8"	11" x 11"	11" x 12"	11" x 13"	DVF8-WT

Note: Telescoping firestop for 360 degree fire protection

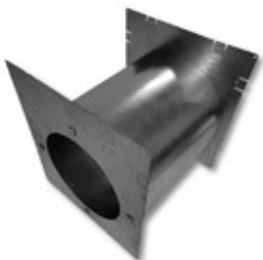

Pro-Form® Wall Thimble Extension



Diameter	Order #
4" inside 6 5/8"	DV6-WTEXT
4" Inside 7"	DV7-WTEXT
5" inside 8"	DV8-WTEXT

Note: Extends telescoping collar 12" - 16" for use in a thicker wall.

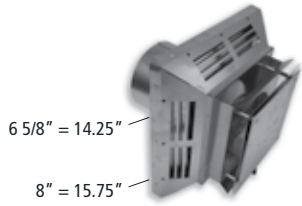

Pro-Form® Horizontal Co-Axial Pyramid Style Caps for Rigid Pipe		C	B	1	6
Diameter	Order #				
4" inside 6 5/8"	DVR6-HCP				
4" Inside 7"	DVR7-HCP				
5" inside 8"	DVR8-HCP				

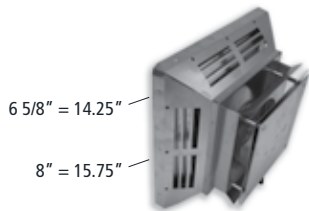

Pro-Form® Horizontal Co-Axial Pyramid Style Caps for Flex Pipe		C	B	1	6
Diameter	Order #				
4" inside 6 5/8"	DVF6-HCP				
4" Inside 7"	DVF7-HCP				
5" inside 8"	DVF8-HCP				

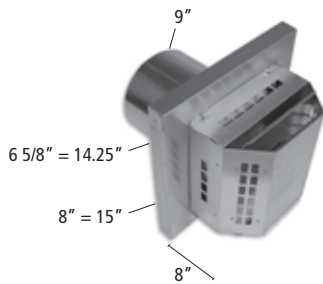

Pro-Form® Horizontal Co-Axial Termination Cap for Rigid Pipe		C	B	1	6
Diameter	Order #				
4" inside 6 5/8"	DVR6-HC				
4" Inside 7"	DVR7-HC				
5" inside 8"	DVR8-HC				

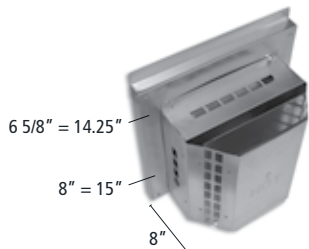

Pro-Form® Horizontal Co-Axial DV Termination Cap (For Flex)		C	B	1	6
Diameter	Order #				
4" inside 6 5/8"	DVF6-HC				
4" Inside 7"	DVF7-HC				
5" inside 8"	DVF8-HC				

Note: Cap includes screws and caulk



Pro-Form® Horizontal Termination Cap Wind/Heat Shroud		C	B	1	6
Diameter	Order #				
4" inside 6 5/8"	DVR6-SHRD				
5" inside 8"	DVR8-SHRD				



Pro-Form® Horizontal Termination Cap Wind/Heat Shroud For Pyramid Cap		C	B	1	6
Diameter	Order #				
4" inside 6 5/8"	DVR6-SHRDPYD				
5" inside 8"	DVR8-SHRDPYD				

Pro-Form® Direct Vent System

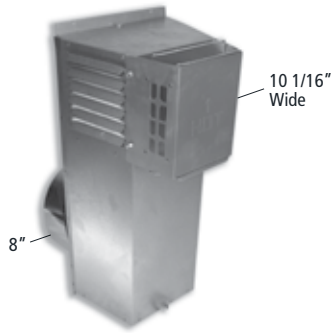

Pro-Form® 14" Snorkel Cap (Aluminum)



Diameter	Order #
4" inside 6 5/8"	DVR6-SNK14
5" inside 8"	DVR8-SNK14

Pro-Form® 36" Snorkel Cap (Aluminum)



Diameter	Order #
4" inside 6 5/8"	DVR6-SNK36
5" inside 8"	DVR8-SNK36



Pro-Form® Vertical Round Co-Axial DV Termination Cap



Diameter	Order #
4" inside 6 5/8"	DVR6-VCH
5" inside 8"	DVR8-VCH



Pro-Form® Vertical Round Co-Axial Cap High Wind Guard



Order #
DVR68-VWG

Note: Fits all diameters

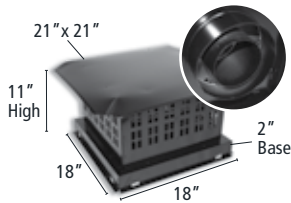

Pro-Form® Vertical Co-Axial DV Termination Caps



Diameter	Order #
4" inside 6 5/8"	DVR6-VCSB
4" Inside 7"	DVR7-VCSB
5" inside 8"	DVR8-VCSB

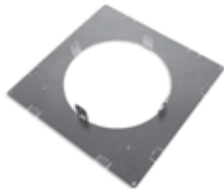

Pro-Form® Ceiling Firestop



Diameter	Framing Dimension	Order #
4" inside 6 5/8"	9.5" x 9.5"	DVR6-CFS
5" inside 8"	11" x 11"	DVR8-CFS

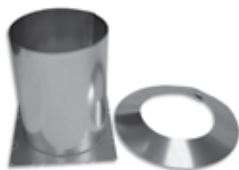

Pro-Form® Attic Insulation Shield (Adjustable) with Firestop



Diameter	Order #
4" inside 6 5/8"	DVR6-AIS
5" inside 8"	DVR8-AIS

Note: Adjusts 11"-21"

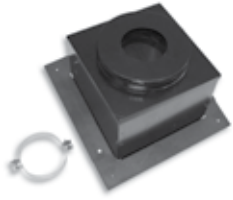

Pro-Form® Cathedral Ceiling Support Kit			C	B	1	6
Diameter	Base	Order #				
4" inside 6 5/8"	12" x 12"	DVR6-CS				
5" inside 8"	13" x 13"	DVR8-CS				

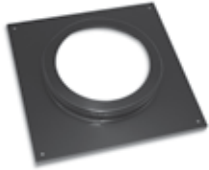

Pro-Form® Decorator Wall Collar			C	B	4	6
Diameter	Base	Order #				
4" inside 6 5/8"	12" x 12"	DVR6-DC				
5" inside 8"	13" x 14"	DVR8-DC				

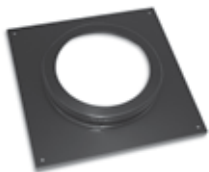

Pro-Form® Flat Ceiling Decorator Collar			C	B	4	6
Diameter	Base	Order #				
4" inside 6 5/8"	12" x 12"	DVR6-FCDC				
5" inside 8"	13" x 13"	DVR8-FCDC				

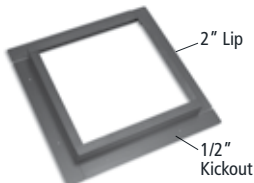

Pro-Form® SS Counter Flashing 4 Pc. Kit				C	B	4	6
Standard		Pyramid Cap					
Diameter	Order #	Diameter	Order #				
4" inside 6 5/8"	DVR6-CFK-SS		DVR6-CFK-SSPYD				
5" inside 8"	DVR8-CFK-SS		DVR8-CFK-SSPYD				

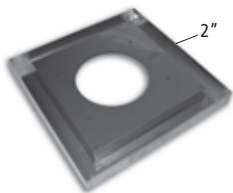

Pro-Form® SS Vinyl Siding Standoff				C	B	1	6
Diameter	I.D.	O.D.	Order #				
For Rigid							
4" inside 6 5/8"	14.5"	18.125"	DVR6-VSS				
5" inside 8"	14.75"	19"	DVR8-VSS				
For Flex							
4" inside 6 5/8"	14.5"	18.125"	DVR6-VSSFLX				
5" inside 8"	14.75"	19"	DVR8-VSSFLX				

Pro-Form® SS Vinyl Siding Standoff – With Pyramid Cap				C	B	1	6
Diameter	I.D.	O.D.	Order #				
For Rigid							
4" inside 6 5/8"	14.5"	18.125"	DVR6-VSSPYD				
5" inside 8"	15.75"	19"	DVR8-VSSPYD				
For Flex							
4" inside 6 5/8"	14.5"	18.125"	DVR6-VSSPYDFLX				
5" inside 8"	15.75"	19"	DVR8-VSSPYDFLX				

Pro-Form® Direct Vent System



Pro-Form® Roof Support



Diameter	Order #
4" inside 6 5/8"	DVR6-RS
5" inside 8"	DVR8-RS



Pro-Form® Adjustable Storm Collar



Diameter	Order #
6 5/8" to 8"	DVR68-SC

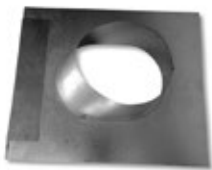

Pro-Form® Adjustable Roof Flashing 7/12 to 12/12



Diameter	Order #
4" inside 6 5/8"	DVR6-AF712
5" inside 8"	DVR8-AF712

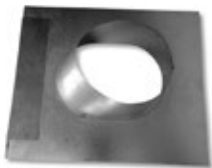

Pro-Form® Adjustable Roof Flashing 0/12 to 6/12



Diameter	Order #
4" inside 6 5/8"	DVR6-AF012
5" inside 8"	DVR8-AF012



Pro-Form® Flat Roof Flashing



Diameter	Order #
4" inside 6 5/8"	DVR6-TCF
5" inside 8"	DVR8-TCF

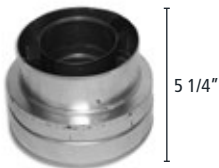

Pro-Form® 6 5/8" to 8" Co-Axial Increaser (Aluminum)



Diameter	Order #
5" inside 8"	DVR6-R8

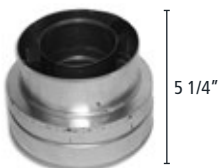

Pro-Form® 8" to 6 5/8" Co-Axial Reducer (Aluminum)



Diameter	Order #
5" inside 8"	DVR8-R6



Pro-Form® Vermont Castings DV Adaptors			
Diameter	Description	Order #	Order #
4" to 6 5/8"	DV Vermont Castings Stove Adaptor	DVR6-STAVC	DVR6-STAVCB



Pro-Form® Valor DV Adaptors		
Diameter	Description	Order #
4" to 6 5/8"	Valor Stove Adaptor	DVR6-08A



Pro-Form® Stove Adaptor / Starter Collar		
Diameter	Description	Order #
7" to 6 5/8"	Starter Collar	DVR6-STA7



Pro-Form® Rigid DV Pipe Adaptor	
Diameter	Order #
4" inside 6 5/8"	DVR6-2DV
5" inside 8"	DVR8-2DV

Note: Connects other Manufacturers DV Pipe to Pro-Form® DV Pipe.



Pro-Form® BDM DV Adaptor-Old Pipe to New Pipe	
Diameter	Order #
4" inside 6 5/8"	94-2DVR6
5" inside 8"	94-2DVR8



Pro-Form® Elbow Strap	
Diameter	Order #
4" inside 6 5/8"	DVR6-ES
5" inside 8"	DVR8-ES

Note: Elbow Straps are sold in 4 packs



Pro-Form® Wall Strap	
Diameter	Order #
4" inside 6 5/8"	DVR6-WS
5" inside 8"	DVR8-WS

Note: Adjusts 1"-3" from wall; Wall straps are sold in 4 packs



Pro-Form® DV Touch Up Paint	
Description	Order #
12 oz	DVR-PAINT

Pro-Form® Direct Vent System

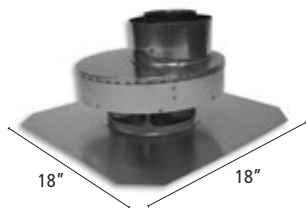

Pro-Form® Co-Linear to Co-Axial Chimney Liner Termination Kit



Diameter	Order #
4" Inside 6 5/8" Co-Axial to 3" x 3" and 3" x 4" Co-Linear	DVF34-TC6

Note: Kit includes Termination Connector and 18" x 18" Flashing
For use when converting from Co-Linear flex to Co-Axial rigid vent. Typically used to extend chimney termination. Each includes a 3" x 4" adaptor.



Width - 8"
Length - 12"
Height - 9"

Pro-Form® Co-Axial to Co-Linear Adaptor (Aluminum)



Diameter	Order #
6 5/8" Co-Axial to 3" x 3" Co-Linear	DVR6-A33
6 5/8" Co-Axial to 3" x 4" Co-Linear	DVR6-A34
6 5/8" Co-Axial to 4" x 4" Co-Linear	DVR6-A44
8 / 5" Co-Axial to 3" x 3" Co-Linear	DVR8-A33
8 / 5" Co-Axial to 3" x 4" Co-Linear	DVR8-A34
8 / 5" Co-Axial to 4" x 4" Co-Linear	DVR8-A44



Width - 8"
Length - 12"
Height - 9"

Pro-Form® Co-Linear to Co-Axial Adaptor (Aluminum)



Diameter	Order #
3" x 3" Co-Linear to 6 5/8" Co-Axial	DVF33-A6
3" x 4" Co-Linear to 6 5/8" Co-Axial	DVF34-A6
4" x 4" Co-Linear to 6 5/8" Co-Axial	DVF44-A6
3" x 3" Co-Linear to 8 / 5" Co-Axial	DVF33-A8
3" x 4" Co-Linear to 8 / 5" Co-Axial	DVF34-A8
4" x 4" Co-Linear to 8 / 5" Co-Axial	DVF44-A8



Pro-Form® Clearance Ring



Diameter	Order #
6 5/8"	DVF6-CR
7"	DVF7-CR
8"	DVF8-CR

Note: For use with flexible DV. Maintains a 3" clearance.



Pro-Form® 5-Piece Co-Axial Insert Kit



Diameter	Order #
3"	DVF33-6CAKT

Kit includes: cap, (1) 30' and (1) 4' length of flex, 18" x 18" Support Plate, 4" to 3" Reducer.



Pro-Form® 4-Piece Co-Axial Insert Kit



Diameter	Order #
4"	DVF44-6CAKT

Kit includes: cap, (1) 30' and (1) 4' length of flex, 18" x 18" Support Plate.